

Oster®

User Manual **Folding Electric Griddle**
Manual de Instrucciones **Plancha Eléctrica Plegable**

MODEL/MODELO **CKSTGRFM40**

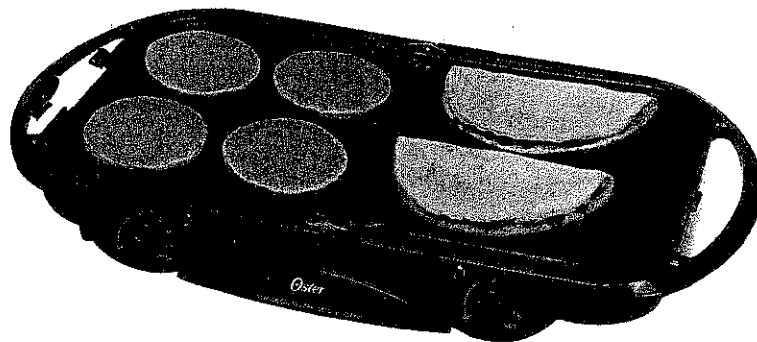

Visit us at www.oster.com

P.N. 142329

IMPORTANT SAFEGUARDS

When using electrical appliances, basic safety precautions should always be followed, including the following:

- Read all instructions before using.
- Do not touch hot surfaces. Use handles or knobs.
- To protect against electrical shock, do not immerse GRIDDLE or cord in water or other liquid.
- Close supervision is necessary when any appliance is used near children. This appliance should not be used by children.
- Unplug from outlet when not in use and before cleaning. Allow to cool before putting on or taking off parts, and before cleaning and folding the appliance.
- Do not operate any appliance with a damaged cord or plug or after the appliance malfunctions or has been damaged in any manner. Return appliance to the manufacturer (see warranty) for examination, repair, or adjustment.
- The use of accessory attachments not recommended by the appliance manufacturer may cause injuries.
- Do not use outdoors.
- Do not let cord hang over edge of table or counter, or touch hot surfaces.
- Do not place on or near a hot gas or electric burner, or in a heated oven.
- Extreme caution must be used when moving an appliance containing hot oil or other hot liquids.
- To disconnect, turn both controls to OFF, then remove plug from wall outlet.
- Do not use appliance for other than intended use.
- Be sure controls are turned to the OFF position and the Griddle has cooled completely before folding. DO NOT TURN UNIT ON WHILE IT IS IN THE FOLDED POSITION.
- DO NOT TURN ON WHILE THE COOKING PLATES ARE REMOVED.

SAVE THESE INSTRUCTIONS

SHORT CORD INSTRUCTIONS

This appliance is for **HOUSEHOLD USE ONLY**. No user-serviceable parts inside. Do not attempt to service this product.

A short power supply cord is provided to reduce the hazards resulting from entanglement or tripping over a longer cord. **AN EXTENSION CORD MAY BE USED WITH CARE; HOWEVER, THE MARKED ELECTRICAL RATING SHOULD BE AT LEAST AS GREAT AS THE ELECTRICAL RATING OF THE GRIDDLE.** The extension cord should not be allowed to drape over the counter or tabletop where it can be pulled on by children or tripped over unintentionally.

POLARIZED PLUG



This appliance has a polarized plug (one blade is wider than the other). To reduce the risk of electric shock, this plug is intended to fit into a polarized outlet only one way. If the plug does not fit fully into the outlet, reverse the plug. If it still does not fit, contact a qualified electrician. Do not attempt to modify the plug in any way. If the plug fits loosely into the AC outlet or if the AC outlet feels warm do not use that outlet.

ELECTRIC POWER: If electric circuit is overloaded with other appliances, the Griddle may not operate properly. The Griddle must be operated on a separate circuit from other operating appliances.

PARTS IDENTIFICATION

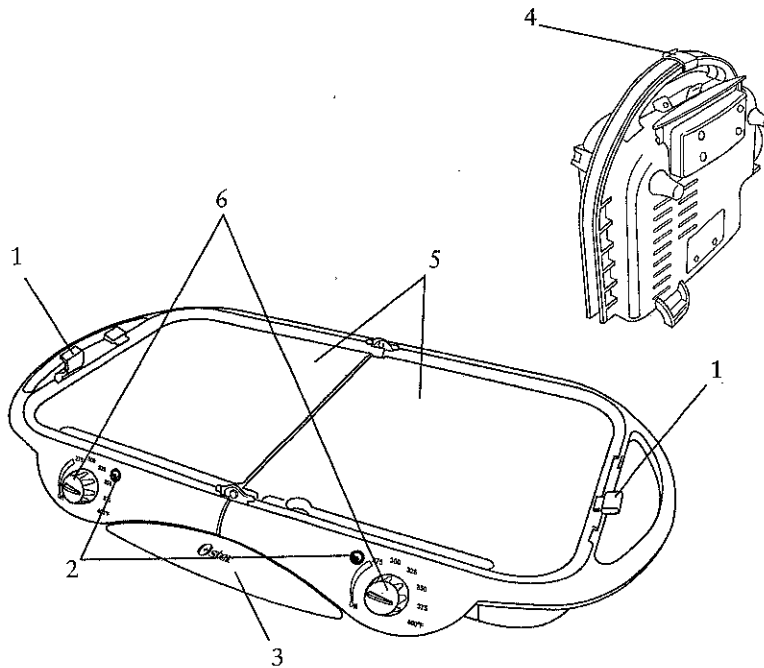

- | | |
|---------------------------------|------------------------------|
| 1. Plate Latch | 4. Handle Latch |
| 2. Temperature Indicator Lights | 5. Cooking Plates |
| 3. Grease Tray | 6. Temperature Control Knobs |

BEFORE FIRST USE

This appliance is designed for indoor use only. It is a stand-alone Griddle. Do not use charcoal, lighter fluids, or gases with this appliance.

- Carefully unpack the Griddle and remove all packaging materials.
- Unfold the Griddle and insert the GREASE TRAY in the front of the unit to lock griddle in open position.
- Remove the COOKING PLATES by pushing down on the COOKING PLATE LATCHES. (See Figure 1)
- Wash the COOKING PLATES and GREASE TRAY with hot, soapy water. Rinse and dry thoroughly. **CAUTION:** Do not immerse the Griddle in water or other liquids.
- Replace the COOKING PLATES. Align special notch area in COOKING PLATES with unit. Hold plates up at a slight angle and slide plates into hinge areas and push down to lock plates. (See Figure 2)

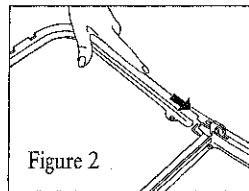
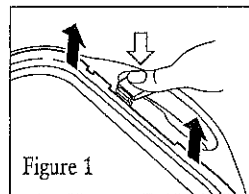

NOTE: Make sure to push down on the COOKING PLATE until it has firmly locked into place under the COOKING PLATE LATCH.

NOTE: COOKING PLATES are not interchangeable and will only fit their intended sides.

- Condition the non-stick COOKING PLATES with vegetable oil, wiping off any excess with a paper towel.

HOW TO USE YOUR FOLDING GRIDDLE

- Place the Griddle on a flat, level surface, such as a countertop or table.
- Replace GREASE TRAY into guides at the front of the Griddle.
- Make sure the TEMPERATURE CONTROL KNOBS are in the “OFF” position.
- Plug Griddle into a 120 volt 60Hz AC outlet.
- Preheat the Griddle by aligning the TEMPERATURE CONTROL KNOB indicator with the appropriate temperature setting for approximately 15 minutes prior to use. The INDICATOR LIGHTS will illuminate, indicating that the Griddle is being preheated. When the INDICATOR LIGHTS go out, the Griddle surface is preheated to the desired temperature and is ready for use. During cooking, the INDICATOR LIGHTS will go on and off indicating that the surface temperature is being maintained.
- The Fold ‘n Store™ Griddle is equipped with dual, independent controls allowing you to cook 2 different kinds of foods at one time. Or it has the ability to warm food on one side and cook food on the other side.
- Use only wood, nylon, or heat-proof plastic utensils. Metal utensils will scratch the non-stick COOKING PLATES of the Griddle. NOTE: Never cut food with a knife on the Griddle.
- When cooking is complete, turn the TEMPERATURE CONTROL KNOBS to the “OFF” position and unplug the POWER CORD from the outlet.
- Allow Griddle to cool before removing COOKING PLATES and GREASE TRAY and cleaning.

NOTE: When cooking consecutive batches of bacon or other high fatty foods, it may be necessary to empty the GREASE TRAY to avoid grease from overflowing.

CAUTION: Some countertops are more sensitive to heat, use care not to place the Griddle on surfaces where heat may cause damage.

COOKING TIME AND TEMPERATURE

FOOD	TEMP.*	TIME	DIRECTIONS
EGGS, fried	300° F	3 to 5 min.	Turn halfway into cooking time.
BACON	350° F	8 to 14 min.	Turn often.
SAUSAGE	350° F	20 to 30 min.	Turn halfway into cooking time.
FRENCH TOAST	350° F	6 to 10 min.	Turn halfway into cooking time.
HAMBURGER	350° F	8 to 14 min.	Turn halfway into cooking time.
HAM SLICES	350° F	14 to 18 min.	Turn halfway into cooking time.
SANDWICHES	350° F	6 to 10 min.	Butter outside and brown both sides.
PORK CHOPS	350° F	20 to 30 min.	Brown both sides, reduce temp. to 250° F. Turn halfway into cooking time.
POTATOES	350° F	10 to 12 min.	Turn halfway into cooking time.
STEAKS			
Rare	400° F	4 to 6 min.	Turn halfway into cooking time.
Medium	400° F	7 to 12 min.	Turn halfway into cooking time.
Well Done	400° F	13 to 18 min.	Turn halfway into cooking time.
PANCAKES	350° F	2 to 6 min.	Pour batter onto griddle. When bubbles appear on top, turn.

* PREHEAT GRIDDLE FOR 15 MINUTES

HOW TO CARE AND CLEAN YOUR FOLDING GRIDDLE

- After using, unplug the POWER CORD from the outlet. Allow Griddle and COOKING PLATES to cool before cleaning.
- Remove COOKING PLATES. (See "BEFORE FIRST USE")
- Remove GREASE TRAY and empty the contents.
- Wipe the Griddle with warm, soapy water. Dry thoroughly.

CAUTION: DO NOT IMMERSE THE GRIDDLE IN WATER OR OTHER LIQUIDS.

- The COOKING PLATES and GREASE TRAY may be washed in the dishwasher. Or you may wash them with hot, soapy water. Rinse and dry thoroughly.

NOTE: Do not use steel wool scouring pads or harsh cleaners on any part of the appliance. If necessary, use a nylon scouring pad.

STORAGE OF YOUR FOLDING GRIDDLE

- Insert the COOKING PLATES. (See "BEFORE FIRST USE")

NOTE: DO NOT replace the GREASE TRAY until the Griddle is locked and folded.

- Fold the griddle and use HANDLE LATCH to lock both handles together.
- After Griddle is folded and handles have been locked in the upright position, you may replace the GREASE TRAY. (See Figure 3 and 4)
- The power cord can be secured on the convenient cord storage when griddle is not in use. (See Figure 5)
- You are now ready to store your extra large Griddle in a compact area.

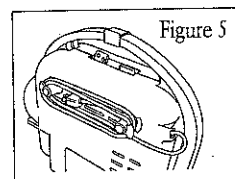
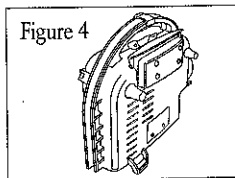
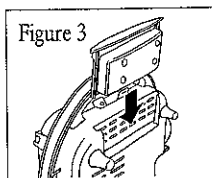

1 Year Limited Warranty

Sunbeam Products, Inc. doing business as Jarden Consumer Solutions or if in Canada, Sunbeam Corporation (Canada) Limited doing business as Jarden Consumer Solutions (collectively "JCS") warrants that for a period of one year from the date of purchase, this product will be free from defects in material and workmanship. JCS, at its option, will repair or replace this product or any component of the product found to be defective during the warranty period. Replacement will be made with a new or remanufactured product or component. If the product is no longer available, replacement may be made with a similar product of equal or greater value. This is your exclusive warranty. Do NOT attempt to repair or adjust any electrical or mechanical functions on this product. Doing so will void this warranty.

This warranty is valid for the original retail purchaser from the date of initial retail purchase and is not transferable. Keep the original sales receipt. Proof of purchase is required to obtain warranty performance. JCS dealers, service centers, or retail stores selling JCS products do not have the right to alter, modify or any way change the terms and conditions of this warranty.

This warranty does not cover normal wear of parts or damage resulting from any of the following: negligent use or misuse of the product, use on improper voltage or current, use contrary to the operating instructions, disassembly, repair or alteration by anyone other than JCS or an authorized JCS service center. Further, the warranty does not cover: Acts of God, such as fire, flood, hurricanes and tornadoes.

What are the limits on JCS's Liability?

JCS shall not be liable for any incidental or consequential damages caused by the breach of any express, implied or statutory warranty or condition.

Except to the extent prohibited by applicable law, any implied warranty or condition of merchantability or fitness for a particular purpose is limited in duration to the duration of the above warranty.

JCS disclaims all other warranties, conditions or representations, express, implied, statutory or otherwise.

JCS shall not be liable for any damages of any kind resulting from the purchase, use or misuse of, or inability to use the product including incidental, special, consequential or similar damages or loss of profits, or for any breach of contract, fundamental or otherwise, or for any claim brought against purchaser by any other party.

Some provinces, states or jurisdictions do not allow the exclusion or limitation of incidental or consequential damages or limitations on how long an implied warranty lasts, so the above limitations or exclusion may not apply to you.

This warranty gives you specific legal rights, and you may also have other rights that vary from province to province, state to state or jurisdiction to jurisdiction.

How To Obtain Warranty Service

In the U.S.A.

If you have any question regarding this warranty or would like to obtain warranty service, please call 1-800-334-0759 and a convenient service center address will be provided to you.

In Canada

If you have any question regarding this warranty or would like to obtain warranty service, please call 1-800-667-8623 and a convenient service center address will be provided to you.

In the U.S.A., this warranty is offered by Sunbeam Products, Inc. doing business as Jarden Consumer Solutions located in Boca Raton, Florida 33431. In Canada, this warranty is offered by Sunbeam Corporation (Canada) Limited doing business as Jarden Consumer Solutions, located at 20 B Hereford Street, Brampton, Ontario L6Y 0M1. If you have any other problem or claim in connection with this product, please write our Consumer Service Department.

**PLEASE DO NOT RETURN THIS PRODUCT TO ANY OF THESE ADDRESSES
OR TO THE PLACE OF PURCHASE.**